

<SPECIFICATION>

SPEC.No. ASDIQ-SPE-099(00)

Date: Jul.23,2022

To :

CUSTOMER'S PRODUCT NAME

ASDI PRODUCT NAME:

SPAC104N-SERIES

RECEIPT CONFIRMATION

UNCONDITIONAL CONSENT

CONDITIONAL CONSENT

APPROVED	CHECKED

ASDI SIGNATURE

APPROVED	CHECKED	PREPARED
Xianglong Li	Liang Wang	Jiayin Cai



Xiamen ASDI Electronics Co.,Ltd.

CAUTION WHEN HANDLING

Before use the products, please read this specification.

CAUTION FOR SAFETY USING

When use the products, be careful to mentioned below for safety using.

CAUTION

*The product should be used within 12 monthes.

Focus on the storage conditions.

Solderability may become weak if it exceeds the period.

*Do not use and store the product in condition of gas corrosion
(Salt,Acid,Alkaline).

*The products must be preheated before soldering.

The operating temperature including self-generated heat must be within '-40~+125℃

*Rework by soldering iron;Please keep the mentioned conditions in this specification.

*In case of insert P.C. Board on chassis, do not add mechanical stress to the product.

*Be careful to arrange of non-magnetic field type inductors.

The error may be caused by magnetic field coupling.

*In case handle the products, please use wrist strap for ground static discharge on human body.

The product keeps away from magnet or magnetized things.

*Do not use the product beyond the mentioned conditions in this specification.

*About an application

The products listed on this specification sheet are intended for use in general electronic equipment

(AV equipment, telecommunications equipment, home appliances, amusement equipment, computer equipment, personal equipment, office equipment, measurement equipment, industrial robots) under a normal operation and use condition.

*The products are not designed or warranted to meet the requirements of the applications listed below, whose performance and/or quality require a more stringent level of safety or reliability, or whose failure, malfunction or trouble could cause serious damage to society, person or property. Please understand that we are not responsible for any damage or liability caused by use of the products in any of the applications below or for any other use exceeding the range or conditions set forth in this specification sheet.

- | | |
|--------------------------------|---|
| 1)Aerospace/Aviation equipment | 6)Transportation control equipment |
| 2)Military equipment | 7)Power-generation control equipment |
| 3)Seabed equipment | which directly endanger human life |
| 4)Safety equipment | 8)Atomic energy-related equipment |
| 5)Medical equipment | 9)Other applications that are not |
| | considered general-purpose applications |

If you intend to use the products in the following applications, please contact our sales office.

Transportation equipment (cars, electric trains, ships, etc.), Public information-processing equipment, Electric heating apparatus / burning equipment, Disaster prevention/crime prevention equipment

When using this product in general-purpose applications, you are kindly requested to take into consideration securing protection circuit/equipment or providing backup circuits, etc., to ensure higher safety.

CUSTOMER Each Corporation	ASDI PART No. SPAC104N-SERIES	CUSTOMER'S DWG NO.
------------------------------	----------------------------------	--------------------

1.SCOPE

Power source inductor for mobile devices such as HDDs, DVCs,DSCs,mobile display panels, portable game devices, compact power supply LCDs, other DC to DC converters

2.INDEX

Listed item	Attachment&Tables	Page
1.Features	Please see (1)	3/6
2.Dimensions	Please see (2)	3/6
3.Recommendend Land pattern	Please see (3)	3/6
4.Part Numbering	Please see (4)	3/6
5.Electrical Specifications	Please see (5)	3/6
6.Reliability Tests	Please see (6)	4/6
7.Soldering	Please see (7)	6/6
8.Packaging Information	Please see (8)	6/6
9.Note	Please see (9)	6/6
10.Standard test conditions	—	

3.Manufacturing Location

China

DWG.NO.	ASDIQ-SPE-099(00)	PAGE 2/6
---------	-------------------	-------------

(1)Features

This specification applies Low Profile Power Inductors.
100% Lead(Pb) & Halogen-Free and RoHS compliant.



(2)Dimensions

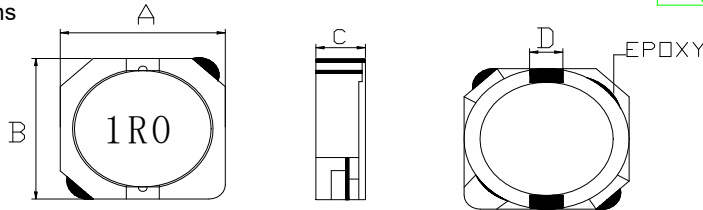

Series	A(mm)	B(mm)	C(mm)	D(mm)
SPAC104N	10.0±0.3	10.2±0.3	3.8±0.2	3.0 REF

(3)Recommend Land pattern

H(mm)	I(mm)	J(mm)
3.6 TYP	1.7 TYP	7.3 TYP

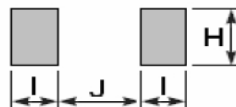

(4)Part Numbering

SPAC **104** **N** - **1R5** **N**
A B C D E

A: Series
 B: Dimension
 C: Control S/N
 D: Inductance 1R5=1.5μH
 E: Inductance Tolerance M=±20%; N=±30%

(5)Electrical Specifications

Table 1

ASDI Part Number	Inductance (μH)	Tolerance (%)	Test Frequency	DCR (Ω) Max	I sat (A)	I rms (A)
SPAC104N-1R0N	1.00	±30%	100kHz/0.25V	0.010	10.0	7.20
SPAC104N-1R5N	1.50	±30%	100kHz/0.25V	0.010	9.5	6.55
SPAC104N-2R2N	2.20	±30%	100kHz/0.25V	0.013	7.5	5.32
SPAC104N-3R3N	3.30	±20%	100kHz/0.25V	0.017	7.0	4.93
SPAC104N-4R7M	4.70	±20%	100kHz/0.25V	0.025	5.5	4.21
SPAC104N-6R8M	6.80	±20%	100kHz/0.25V	0.032	5.0	3.92
SPAC104N-100M	10.0	±20%	100kHz/0.25V	0.037	4.4	3.51
SPAC104N-150M	15.0	±20%	100kHz/0.25V	0.060	3.6	3.20
SPAC104N-220M	22.0	±20%	100kHz/0.25V	0.083	2.8	2.21
SPAC104N-330M	33.0	±20%	100kHz/0.25V	0.106	2.2	1.74
SPAC104N-470M	47.0	±20%	100kHz/0.25V	0.138	2.0	1.62
SPAC104N-560M	56.0	±20%	100kHz/0.25V	0.200	1.6	1.26
SPAC104N-680M	68.0	±20%	100kHz/0.25V	0.235	1.4	1.12
SPAC104N-101M	100.0	±20%	100kHz/0.25V	0.340	1.3	1.10
SPAC104N-151M	150.0	±20%	100kHz/0.25V	0.540	1.1	0.90
SPAC104N-221M	220.0	±20%	100kHz/0.25V	0.780	0.9	0.73
SPAC104N-331M	330.0	±20%	100kHz/0.25V	1.150	0.7	0.58

Note:

Isat: Based on inductance change ($\Delta L/L_0$: \cong -35%) @ ambient temp. 25°C

Irms: Based on temperature rise (ΔT : 40°C typ.)

DWG.No.	ASDIQ-SPE-099(00)	PAGE 3/6
---------	-------------------	-------------

(6)Reliability Tests

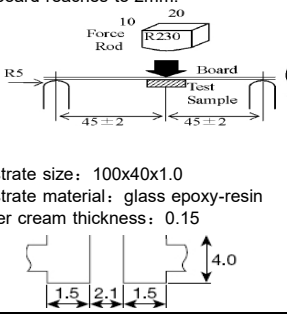
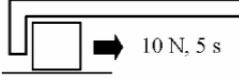
No.	Test item	Performance	Test details
1	Operating temperature	-40 ~ +125℃	Including self-generated heat
2	Storage temperature	-40 ~ +85℃. - 5 to 40℃ for the product with taping.	
3	Rated current	Within the specified tolerance	
4	Inductance (L)		LCR Meter: HP 4285A or equivalent, 100kHz, 0.25V
5	DC Resistance		DC Ohmmeter: HIOKI3227 or equivalent
6	Temperature characteristics	Inductance change: Within±20%	Measurement of inductance shall be taken at temperature rang within-40℃ to +85℃. With reference to inductance value at+20℃,change rate shall be calculated. Measurement of inductance shall be taken at temperature rang within-40℃ to +125℃. With reference to inductance value at+20℃,change rate shall be calculated.
7	Resistance to flexure substrate	No damage	<p>The test samples shall be soldered to the testing board by the reflow. As illustrated below, apply force in the direction of the arrow indicating until deflection of the test board reaches to 2mm.</p>  <p>Substrate size: 100x40x1.0 Substrate material: glass epoxy-resin Solder cream thickness: 0.15</p>
8	Adhesion of Terminal electrode	Shall not come off PC board.	<p>The test samples shall be soldered to the testing board and by the reflow.</p>  <p>Applied force: 10 N to X and Y directions. Duration: 5s Solder cream thickness: 0.15</p>
9	Resistance to Vibration	Inductance change: Within±10% No abnormality observed in appearance.	<p>The test samples shall be soldered to the test board by the reflow. Then it shall be submitted to below test conditions.</p> <p>Frequency: 10-55Hz Total Amplitude: 1.5mm (May not exceed acceleration 196m/S²) Sweeping Method:10Hz to 55Hz to 10Hz for 1min. Time: 2 hours each in X,Y, and Z Direction. Recovery: At least 2hrs of recovery under the standard condition after the test, followed by the measurement within 48hrs.</p>
10	Solderability	At least 90% of surface of terminal electrode is covered by new solder.	<p>The test samples shall be dipped in flux, and then immersed in molten solder as shown in below.</p> <p>Flux: methanol solution containing rosin 25% Solder temperature: 245±5℃ Time: 5±1.0 sec. Immersion depth: All sides of mounting terminal shall be immersed.</p>

No.	Test item	Performance	Test details															
11	Resistance to soldering	Inductance change: Within±10% No abnormality observed in appearance.	The test sample shall be exposed to reflow oven at 230±5℃ for 40 seconds, with peak temperature at 260±5℃ for 5 seconds,2 times. Test board thickness: 1.0mm Test board material: glass epoxy-resin															
12	Thermal shock		The test samples shall be soldered to the test board by the reflow. The test samples shall be placed at specified temperature for specified time by step 1 to step 4 as shown below in sequence. The temperature cycles shall be repeated 100 cycles . <table border="1"> <thead> <tr> <th>Phase</th> <th>Temperature(℃)</th> <th>Time(min.)</th> </tr> </thead> <tbody> <tr> <td>1</td> <td>-40±3℃</td> <td>30±3</td> </tr> <tr> <td>2</td> <td>Room Temp</td> <td>Within 3</td> </tr> <tr> <td>3</td> <td>85±2℃</td> <td>30±3</td> </tr> <tr> <td>4</td> <td>Room Temp</td> <td>Within 3</td> </tr> </tbody> </table>	Phase	Temperature(℃)	Time(min.)	1	-40±3℃	30±3	2	Room Temp	Within 3	3	85±2℃	30±3	4	Room Temp	Within 3
Phase	Temperature(℃)		Time(min.)															
1	-40±3℃		30±3															
2	Room Temp		Within 3															
3	85±2℃		30±3															
4	Room Temp		Within 3															
13	Damp heat life test	Test Method and Remarks The test samples shall be soldered to the test board by the reflow. The test samples shall be placed in thermostatic oven set at specified temperature and humidity as shown in below. Temperature: 60±2℃ Humidity: 90~95%RH Time: 500+24/-0 hrs																
14	Loading under damp heat life test	The test samples shall be soldered to the test board by the reflow. The test samples shall be placed in thermostatic oven set at specified temperature and humidity and applied the rated current continuously as shown in below. Temperature: 60±2℃ Humidity: 90~95%RH Applied current: Rated current Time: 500+24/-0 hrs																
15	Low temperature life test	The test samples shall be soldered to the test board by the reflow. After that, the test samples shall be placed at test conditions as shown in below. Temperature:-40±2℃ Time:500+24/-0 hrs																
16	Loading at high temperature life test	The test samples shall be soldered to the test board by the reflow. Temperature: 85±2℃. Applied current: Rated current Time: 500+24/-0 hrs.																

(7)Soldering

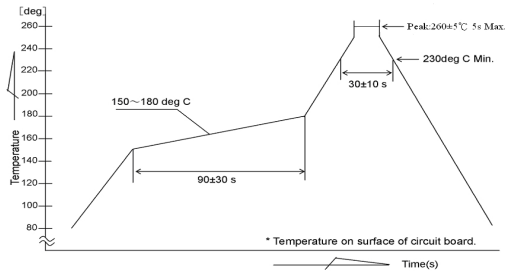

(8)Packaging Information
8-1,Reel Dimension

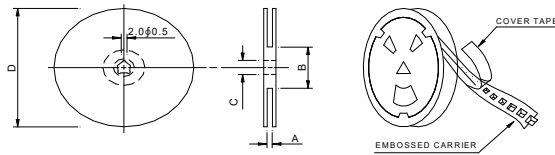

Type	A(mm)	B(mm)	C(mm)	D(mm)
SPAC104N	24.4±0.2	100±4.0	13.2±0.2	330±2.0

8-2,Tape Dimension

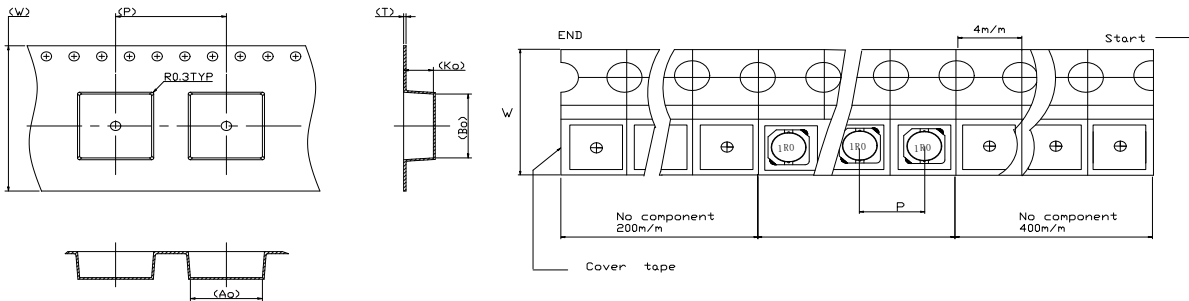

Type	Ao(mm)	Bo(mm)	Ko(mm)	P(mm)	W(mm)	T(mm)
SPAC104N	10.6±0.1	10.65±0.1	4.2±0.1	16.0±0.1	24±0.3	0.35±0.05

8-3,Packaging Quantity

Type	Chip / Reel
SPAC104N	1000

(9)Note

·Storage Conditions

To maintain the solderability of terminal electrodes:

- ASDI products meet IPC/JEDEC J-STD-020D standard-MSL, level 1.
- Temperature and humidity conditions: Temperature: 5 to 30deg.C, Humidity: 75% Max.
- Recommended products should be used within 12 months form the time of delivery.
- The packaging material should be kept where no chlorine or sulfur exists in the air.

·Transportation

- Products should be handled with care to avoid damage or contamination from perspiration and skin oils.
- The use of tweezers or vacuum pick up is strongly recommended for individual components.
- Bulk handling should ensure that abrasion and mechanical shock are minimized.

DWG.No.	ASDIQ-SPE-099(00)	PAGE 6/6
---------	-------------------	-------------